

# INSTRUCTIONS POUR MONTAGE DE L'ELECTROPISTON

## *Prima Base* série 25910

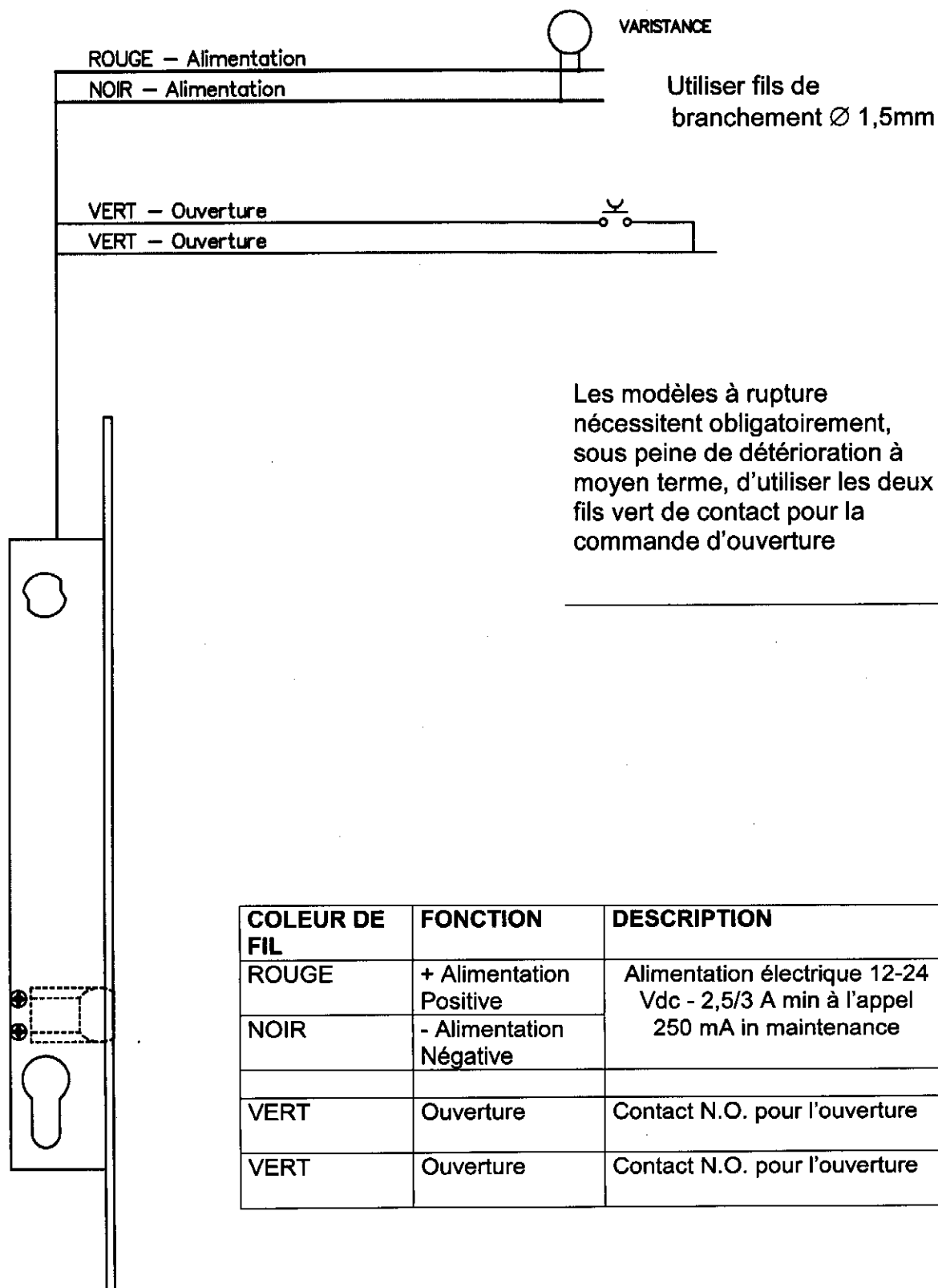

REVERSIBILITÉ

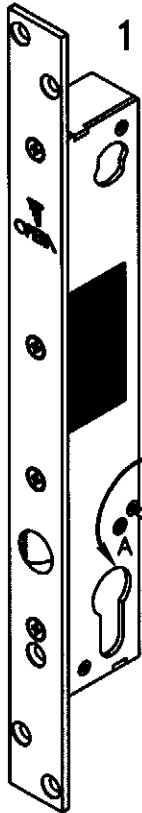

1

2 TOURS MAXIMUM DANS LE SENS CONTRAIRE A CELUI DES AIGUILLES D'UNE MONTRE

DESSERRER LA VIS CRUCIFORME AVEC UN TOURNEVIS PH.1

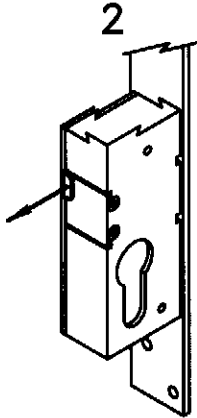

2

TIRER LA PETITE LANGUETTE JUSQU' A L'OUVERTURE DU TROU "A"

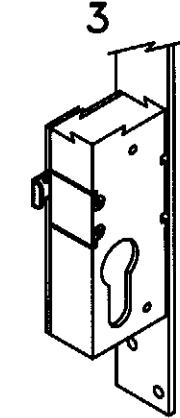

3

PETITE LANGUETTE TIRÉE

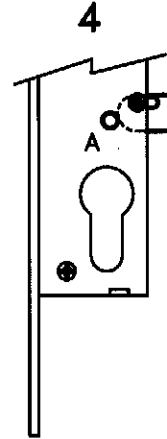

4

TROU "A" OUVERT

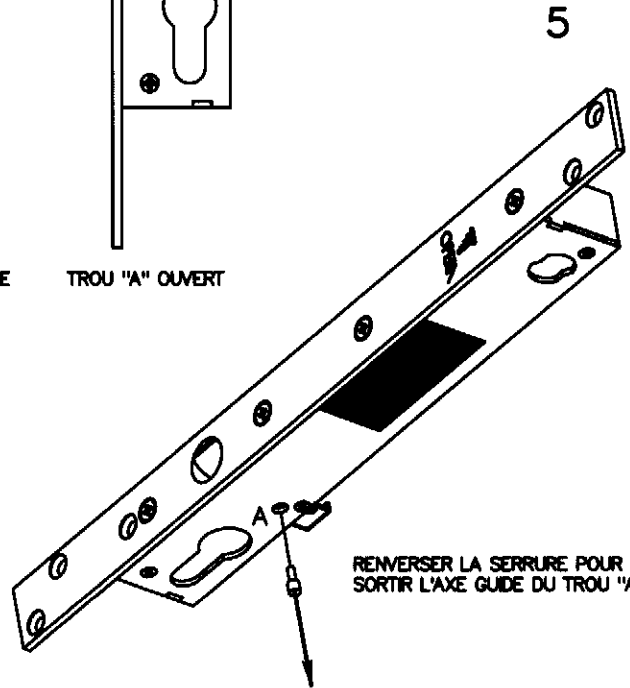

5

RENVERSER LA SERRURE POUR FAIRE SORTIR L'AXE GUIDE DU TROU "A"

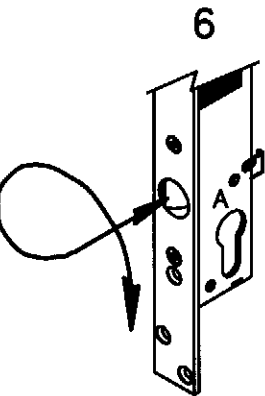

6

TOURNER DE 180° LE PENE 1/2 TOUR



7

LE PENE 1/2 TOUR TOURNE

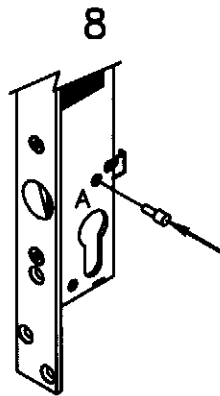

8

INSERER L'AXE DANS LE TROU "A"

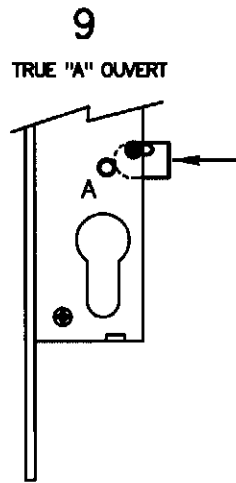

9

TROU "A" OUVERT

TOURNER LA PETITE LANGUETTE VERS L'INTERIEUR JUSQU'A LA FERMETURE DU TROU "A"

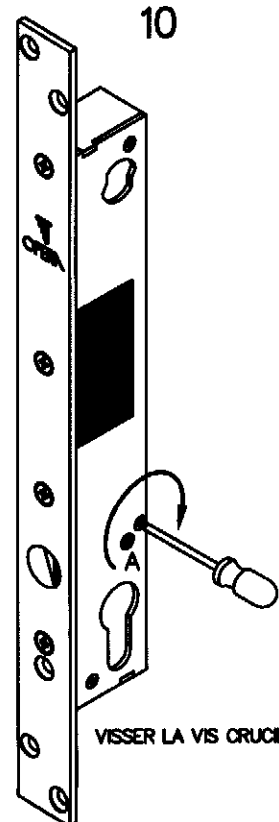

10

VISSER LA VIS CRUCIFORME